

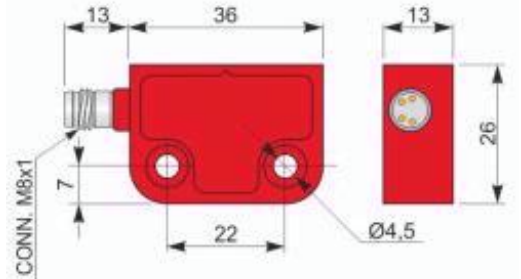

Part number: QMP000008 - Model: SMS36-P5 2NC H1 PL



Dimension in mm

TECHNICAL CHARACTERISTICS

Rated operational voltage Ue:	24 Vac/dc
Rated operational current Ie:	0.25A
Max switching load:	6W (resistive load)
Function:	2NC (with magnetic actuator present)
Thermal current ITh:	0.25A
Rated insulation voltage Ui:	60Vac / 75Vdc
Rated impulse withstand voltage Uimp:	1.5KV
Electrical endurance:	1 million of cycles
Assured operating distance Sao:	5 mm with target AMS36-P5
Assured release distance Sar:	15mm with target AMS36-P5
Repeat accuracy:	< 10%
Switching distance:	200Hz
Response time:	
SIL level (SIL CL):	up to SIL3 according to IEC 62061 e EN 62061
Performance level (PL):	up to PL e according to EN ISO 13849-1
Safety category:	up to 4 according to EN ISO 13849-1
B10d for each channel:	400.000 cycles (full load: DC12, 24V, 0.25A) e 20.000.000 of cycles (with AECO safety Module)
Conformig to the standard:	EN 60947-1, IEC 60947-1, EN 60947-5-1, IEC 60947-5-1, EN 60947-5-2, IEC 60947-5-2, EN 60947-5-3 , IE
Conforms to the directives:	2006/42/EC - Machinery Directive and 2014/30/EU - Electromagnetic Compatibility Directive
Temperature limits:	-25 ÷ +80°C
Protection degree:	IP67
Pollution degree:	3
Schock resistance:	30gn -11ms according to IEC 60068-2-27 and EN 60068-2-27
Vibrations resistance:	10gn-(10 ... 150Hz) according to IEC 60068-2-6 and EN 60068-2-6
Housing material:	PBT +FV



Part number: QMP000008 - Model: SMS36-P5 2NC H1 PL

WIRING DIAGRAM

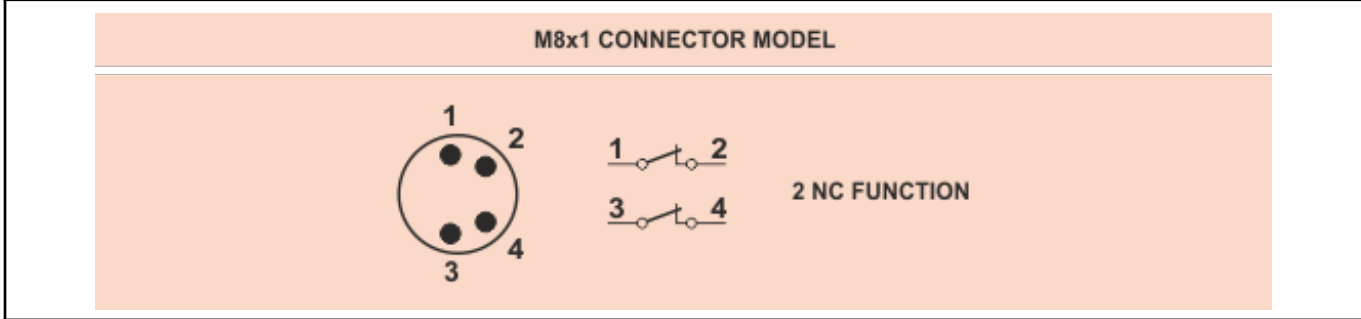

INSTRUCTIONS FOR CORRECT INSTALLATION

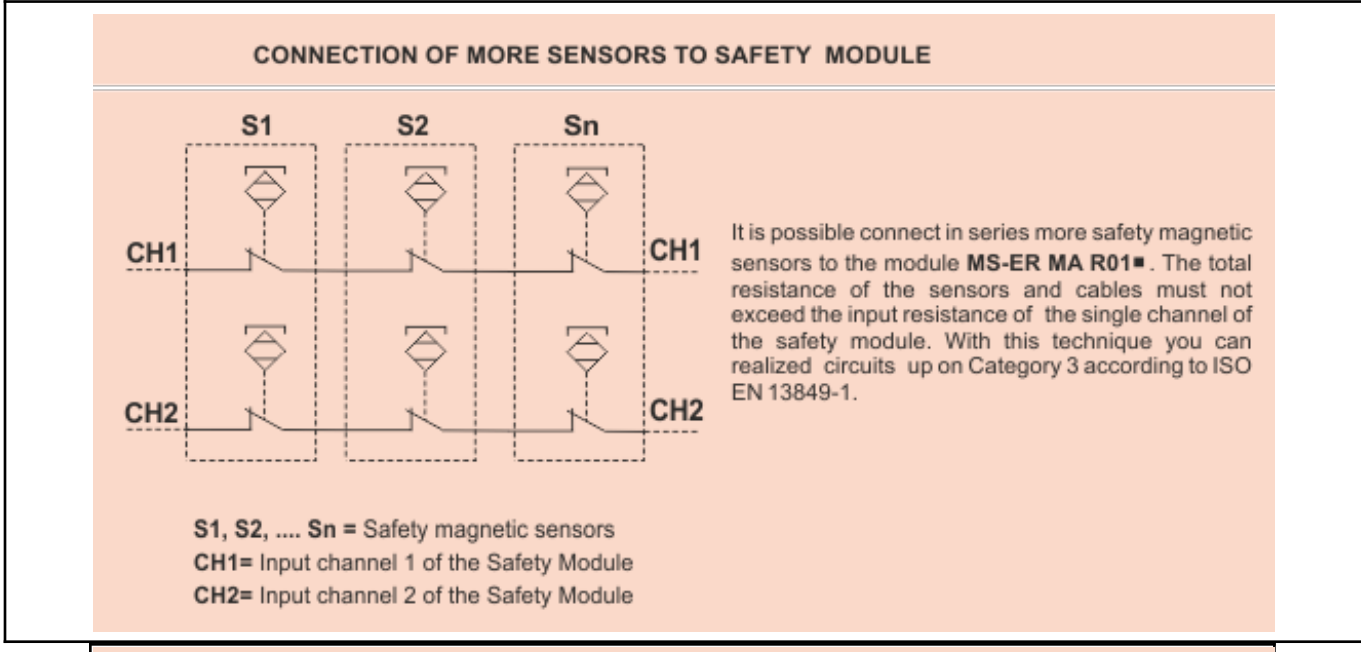

APPLICATIVE CONFIGURATION WITH AECO SAFETY MODULE MS-ER MA R01 ■ SERIES

2 CHANNELS CONFIGURATION WITH MANUAL START

Use models SMS36-P5 2NC ■■ or SMS36-P5 NO+2NC ■■ only

SAFETY PARAMETER
 Integrity Level: SIL3
 Performance Level: PLe
 Category: 4

N.B. To realize a circuit with automatic start to replace the button with a jumper between terminals S12 and S34.

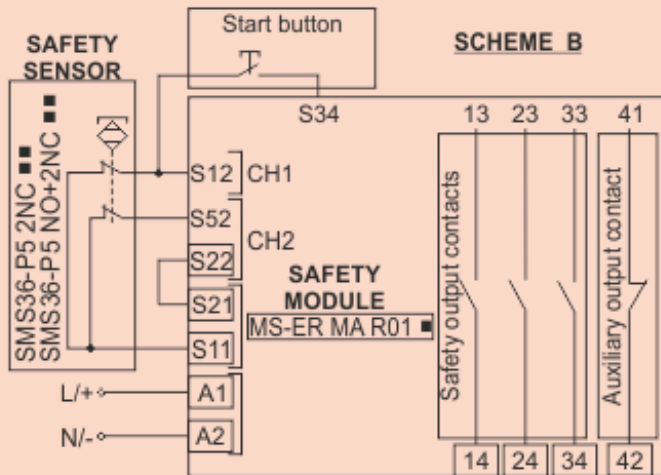
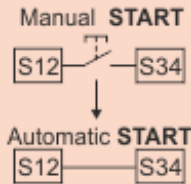

APPLICATIVE CONFIGURATION WITH AECO SAFETY MODULE MS-ER MA R01 ■ SERIES

2 CHANNELS CONFIGURATION WITH MANUAL START

Use models SMS36-P5 2NC ■■ or SMS36-P5 NO+2NC ■■ only

SAFETY PARAMETER
 Integrity Level: SIL3
 Performance Level: PLe
 Category: 4

N.B. To realize a circuit with automatic start to replace the button with a jumper between terminals S12 and S34.

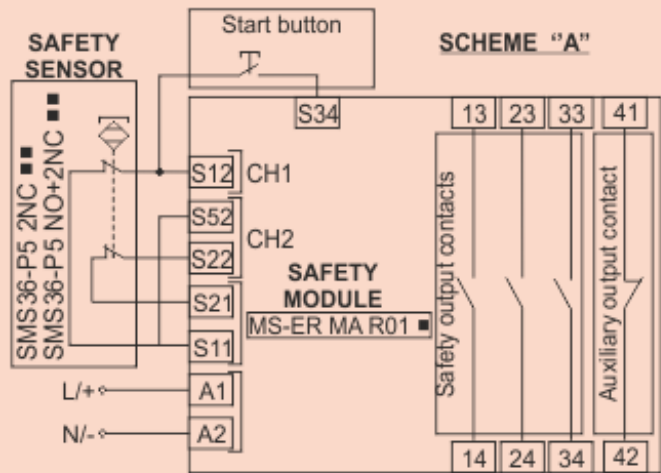
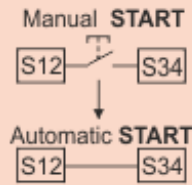

ACTUATING DIRECTIONS

The possible actuating directions are indicated of the arrows.

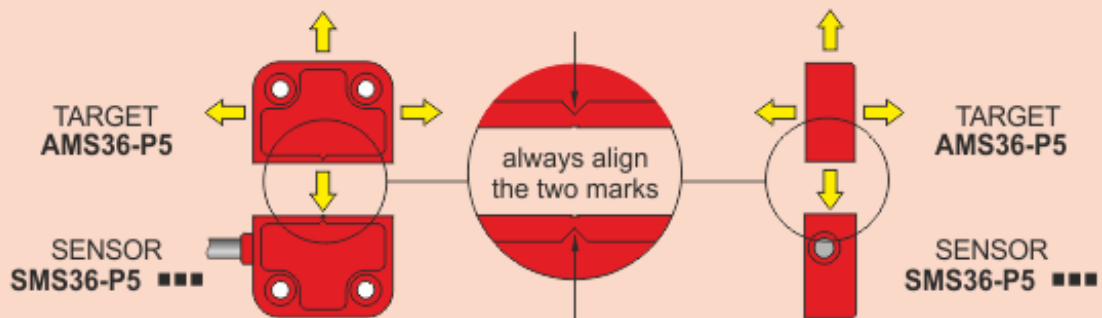

MULTIPLE SENSOR-ACTUATOR SYSTEMS ASSEMBLY

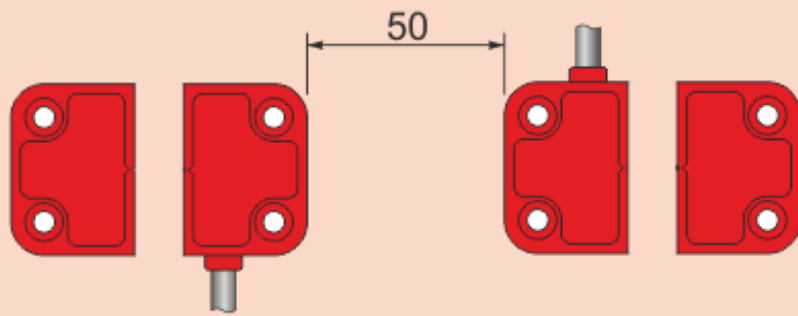

N.B. The minimum distance between *sensor-actuator* systems must be at least 50mm.

SWITHING DISTANCE

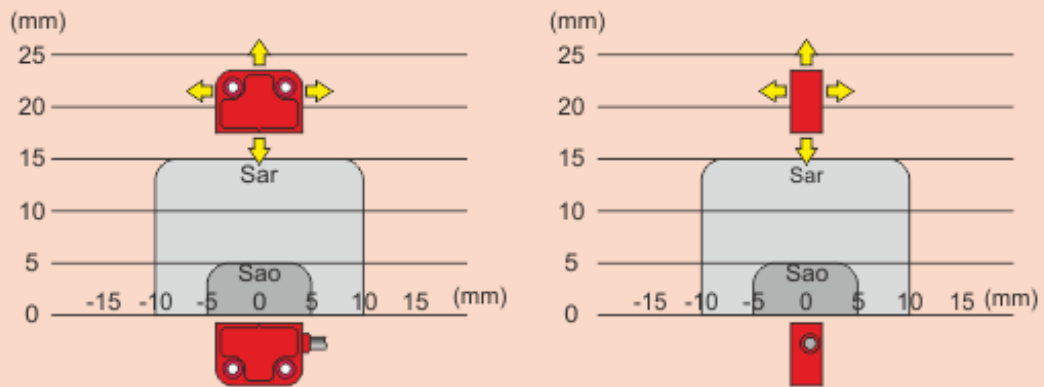

N.B. The drawing of the activation areas is indicative.